

ALPHA[™] iQ

Instructions for installation and use - English
Electric robotic cleaner
Translation of the original instructions in french

EN

 **iAquaLink**[™]
CONTROL

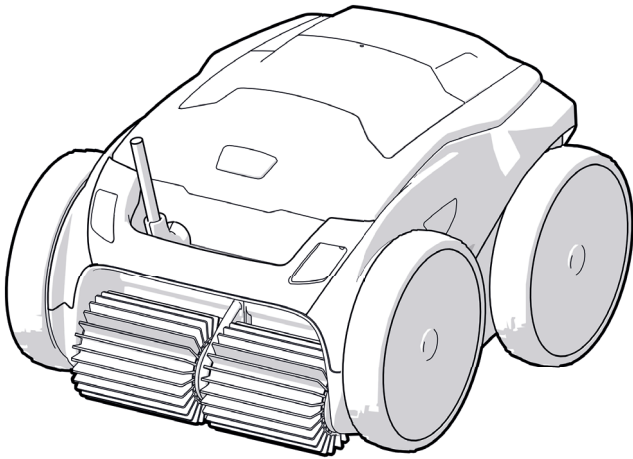

More documents on:
www.zodiac.com

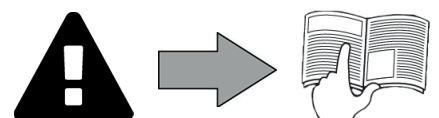

WARNINGS

GENERAL WARNINGS

- Failure to respect the warnings may cause serious damage to the pool equipment or cause serious injury, even death.
- Only a person qualified in the technical fields concerned (electricity, hydraulics or refrigeration) is authorised to perform any servicing or repairs to the appliance. The qualified technician working on the appliance must use/wear personal protective equipment (such as safety goggles and protective gloves, etc.) in order to reduce the risk of injury occurring when working on the appliance.
- Before handling the machine, ensure that power is switched off and isolated from the power supply.
- The appliance is intended to be used with pools for a specific purpose; it must not be used for any purpose other than that for which it was designed.
- This appliance is not intended for use by persons (including children) with reduced physical, sensory or mental capabilities or lack of experience and knowledge, unless they have been given supervision or instruction concerning use of the appliance by a person responsible for their safety.
- Keep the appliance out of the reach of children.
- The appliance must be installed according to the manufacturer's instructions and in compliance with local standards. The installer is responsible for installing the appliance and for compliance with national installation regulations. Under no circumstances may the manufacturer be held liable in the event of failure to comply with applicable local installation standards.
- For any work other than the simple user maintenance described in this manual, the product should be referred to a qualified professional.
- Incorrect installation and/or use may cause serious damage to property or serious injuries (possibly causing death).
- All equipment, even postage and packing paid, travels at the risks and perils of the recipient. The latter shall issue reserves in writing on the carrier's delivery slip if damage is detected, caused during transport (confirmation to be sent to the carrier within 48 hours by registered letter).
- If the appliance suffers a malfunction, do not try to repair it yourself; instead contact a qualified technician.
- Refer to the warranty conditions for details of the permitted water balance values for operating the appliance.
- Deactivating, eliminating or by-passing any of the safety mechanisms integrated into the appliance shall automatically void the warranty, in addition to the use of spare parts manufactured by unauthorised third-party manufacturers.
- Do not spray insecticide or any other chemical (inflammable or non-inflammable) in the direction of the appliance, as this may damage the body and cause a fire.
- Do not touch the fan or moving parts and do not place any objects or your fingers in the vicinity of the moving parts during operation of the appliance. Moving parts can cause serious injury or even death.

WARNINGS ASSOCIATED WITH ELECTRICAL APPLIANCES

- The electrical supply to the appliance must be protected by a dedicated 30 mA differential residual current protection device (RCD), complying with the standards and regulations in force in the country in which it is installed.
- Do not use any extension lead when connecting the appliance; connect the appliance directly to a suitable power supply circuit outlet.
- Before carrying out any operations, check that:
 - The required input voltage indicated on the appliance rating plate corresponds with the mains supply voltage;
 - The mains supply service is compatible with the power requirements of the appliance and is properly grounded;
 - The plug (where applicable) is compatible with for the socket.
- In the event of abnormal operation or the release of odours from the appliance, turn it off immediately, unplug it from its power supply and contact a professional.
- Before any access to the appliance for service or maintenance, ensure that it is switched off and completely disconnected from the power supply. Furthermore, in addition to confirming that the heating priority (where applicable) is deactivated, ensure that any other equipment or accessories connected to the appliance are also disconnected from the power supply circuit.
- Do not disconnect and reconnect the appliance to the power supply when in operation.
- Do not pull on the power cord to disconnect it from the power supply.
- If the power cord is damaged, it must be replaced only by the manufacturer or an authorized representative or repair facility.
- Do not perform maintenance or servicing operations on the appliance with wet hands or if the appliance is wet.
- Before connecting the appliance to the source of supply, ensure that the terminal block or supply socket to which the appliance will be connected is in good condition and is not damaged or corroded in any way.
- For any component or sub-assembly containing a battery: do not recharge or dismantle the battery, or throw it into a fire. Do not expose it to high temperatures or direct sunlight.
- In stormy weather, disconnect the appliance from the power supply to prevent it from suffering lightning damage.
- Do not immerse the appliance in water (with the exception of cleaners) or mud.

SPECIFIC FEATURES APPLICABLE TO "Pool cleaners"

- The cleaner is designed to properly operate in pool water with a temperature of between 15°C and 35°C.
- To avoid possible injury and damage to the cleaner, do not operate the cleaner out of the water.
- In order to prevent possible injury, bathing is prohibited when your cleaner is in the pool.
- Do not use the cleaner during shock chlorination.
- Do not leave the cleaner unattended for an extended period.

WARNING ON THE USE OF A CLEANER IN A POOL WITH A VINYL SURFACE:

- Before installing your new cleaner, carefully inspect the lining of your pool. If the liner has eroded in some areas, or if you notice gravel, folds, roots or corrosion caused by metal on the inner surface of the liner, or if you notice that the support (bottom and walls) is damaged, do not install the cleaner before performing the necessary repairs or before replacing the liner using a qualified professional. The manufacturer cannot be held liable in any way for damage caused to the liner.
- The surface of certain vinyl patterned surfaces can wear rapidly and the patterns disappear on contact from objects such as cleaning brushes, toys, inflatable buoys, chlorine distributors and automatic pool cleaners. The decoration on some vinyl surfaces can be scratched or worn by basic friction such as through the use of a pool brush. The colours of certain patterns can also be erased during use or when in contact with objects in the pool. The erased patterns, wear or scratching of vinyl surfaces are not the liability of the manufacturer of the pool cleaner and are not covered by the limited warranty.

Recycling



This symbol means that your appliance should not be disposed of with other rubbish. It will be selectively collected for the purpose of reuse, recycling or transformation. If it contains any substances that may be harmful to the environment, these will be eliminated or neutralised.

Contact your retailer for recycling information.



- Before you do anything with the device, it is vital that you read this installation and user manual, as well as the "warnings and warranty" booklet delivered with the device. Failure to do so may result in material damage or serious or fatal injury and will invalidate the warranty.
- Keep these documents for future reference and pass them on throughout the device's service life.
- Distributing or modifying this document in any way without authorisation from Zodiac® is prohibited.
- Zodiac® is constantly developing its products to improve their quality; therefore, the information contained in this document may be modified without notice.

CONTENTS

EN



1 Specifications 3

1.1 Package contents	3
1.2 Cleaner functions	4
1.3 Technical specifications and marking	5



2 Installation 6

2.1 Set-up	6
2.2 Assembling the caddy	7



3 General use 8

3.1 Operating principle	8
3.2 Pool preparation	8
3.3 Immersing the cleaner in the pool water	8
3.4 Electrical supply connections	9
3.5 Starting and stopping a cleaning cycle	10



4 Control using the iAquaLink™ app 12

4.1 Connecting to the iAquaLink™ app	12
4.2 iAquaLink™ control	14



5 Maintenance 16

5.1 Cleaning the cleaner	16
5.2 Cleaning the filter	16
5.3 Cleaning the propeller	17
5.4 Replacing the brushes	18
5.5 Changing the tyres	19



6 Troubleshooting 20

6.1 Appliance behaviour	20
6.2 Error codes	21
6.3 Troubleshooting the connection to the iAquaLink™ app	22



Tip: to make it easier to contact your dealer

Write down your retailer's contact details to help you find them more easily and fill in the "product" information on the back of the manual; your dealer will ask you for this information.



1 Specifications



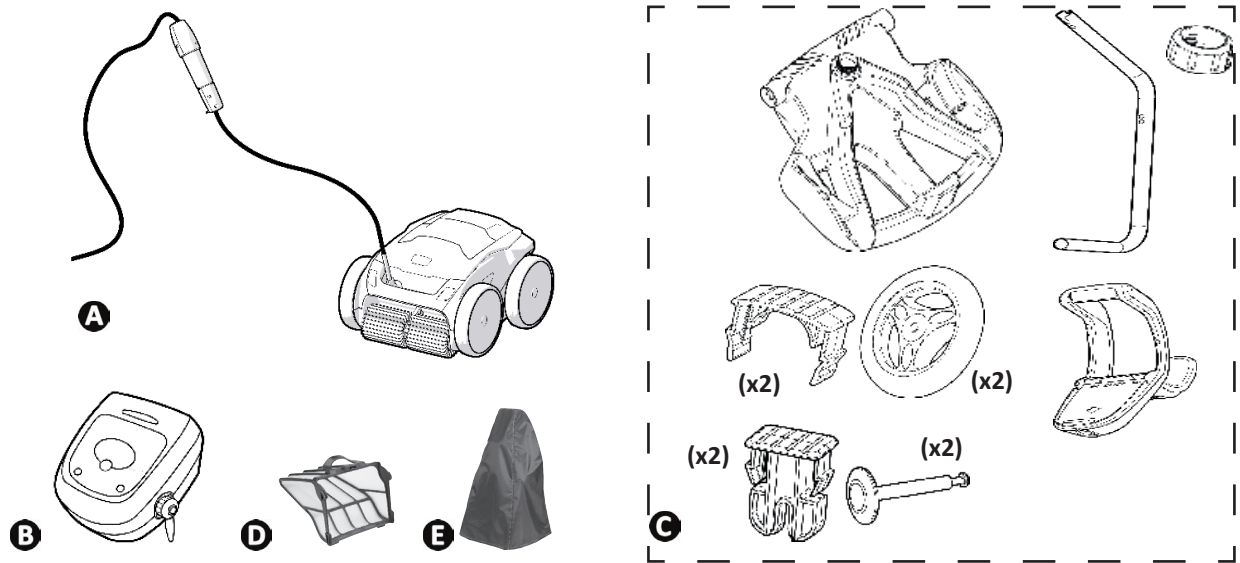















1.1 I Package contents



		RA 6300 iQ - RA 6370 iQ - RA 6500 iQ - RA 6570 iQ - RA 6700 iQ
A	Cleaner + floating cable	✓
B	Control unit	✓
C	Caddy kit	✓
D	60µm very fine debris filter	✓
	200µm large debris filter 100µm fine debris filter	+
E	Protective cover	+

✓: Supplied +: Available as an option

➤ 1.2 I Cleaner functions

Symbol	Designation	RA 6300 iQ - RA 6370 iQ	RA 6500 iQ - RA 6570 iQ	RA 6700 iQ
Control unit :				
	Start/Stop the appliance	✓	✓	✓
	Initiate iAquaLink™ Control connection	✓	✓	✓
	Bluetooth™ connection status	✓	✓	✓
	Wi-Fi connection status	✓	✓	✓
	Remove from pool mode «Lift System»	✓	✓	✓
	Select a cleaning mode	✓	✓	✓
	Quick mode (quick cleaning of the Bottom only)	✓	✓	✓
	Smart mode (optimised cleaning of Bottom + sides + water line)	✓	✓	✓
	Ultra mode (Intensive Bottom + sides + water line cleaning)		✓	✓
	Waterline only mode			✓
	Increase or reduce the cleaning time (+/- 15 minutes)		✓	✓
	« Full filter» indicator	✓	✓	✓
	Information LED	✓	✓	✓
	Error code or message display		✓	✓
Smartphone via the iAquaLink™ app:				
	Start-up, shutdown and monitoring the cleaning cycle	✓	✓	✓
	Remote control mode		✓	✓
	«Spot Cleaning» mode (1m ² around the cleaner)			✓
	Cleaning cycle programming on 7 days		✓	✓
	Information	✓	✓	✓
°C/°F	Water temperature display			✓

✓ : Available

EN

➤ 1.3 I Technical specifications and marking

1.3.1 Technical specifications

	RA 6300 iQ - RA 6370 iQ- RA 6500 iQ - RA 6570 iQ	RA 6700 iQ
Control unit supply voltage 	220-240 V ac, 50 Hz, short circuit-proof safety isolating type*	
Cleaner supply voltage	30 V dc	
Maximum absorbed power	150 W	
Cable length	18 m	21 m
Cleaner dimensions (L x W x H)	43 x 48 x 27 cm	
Package dimensions (L x W x H)	56 x 56 x 46 cm	
Cleaner weight	10.2 kg	
Packed weight	21 kg	22.3 kg
Frequency band	2.412 GHz - 2.484 GHz	
Radio output power	+20 dBm	

* This cleaner utilizes a double-insulated construction. An appliance which uses such construction is one that has been designed in such a way that it does not require an earth/ground connection between the appliance and its power supply. This type of construction helps mitigate exposure of the user to potentially hazardous electrical conditions without relying on an earthed (grounded) metal enclosure. It incorporates the use of two layers of insulating material surrounding the live electrical parts or by using reinforced insulation. Through the use of this type of double-insulated construction, this cleaner does not utilize or require a grounded (three-prong) cord/plug.

1.3.2 Marking

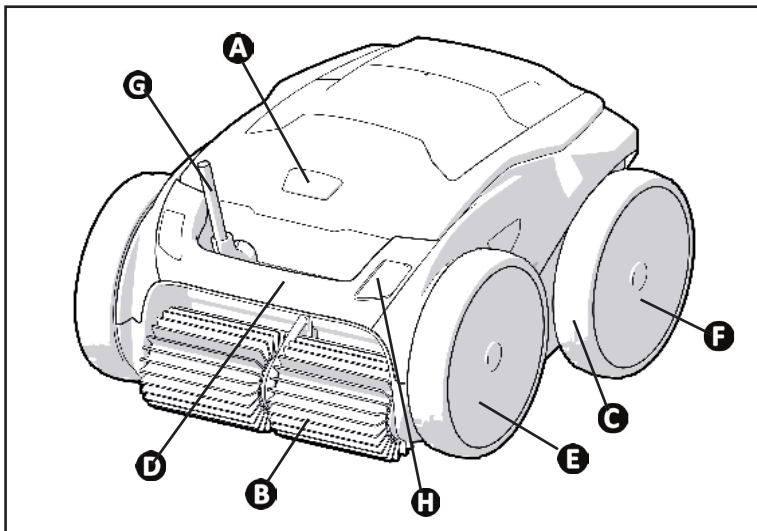

- A**: Filter access hatch lock
- B**: Brushes
- C**: Tyres
- D**: Transport and removal from pool handle
- E**: Front drive wheels
- F**: Rear drive wheels
- G**: Floating cable
- H**: Sensor aerea (in accordance to the model)



2 Installation

2.1 | Set-up

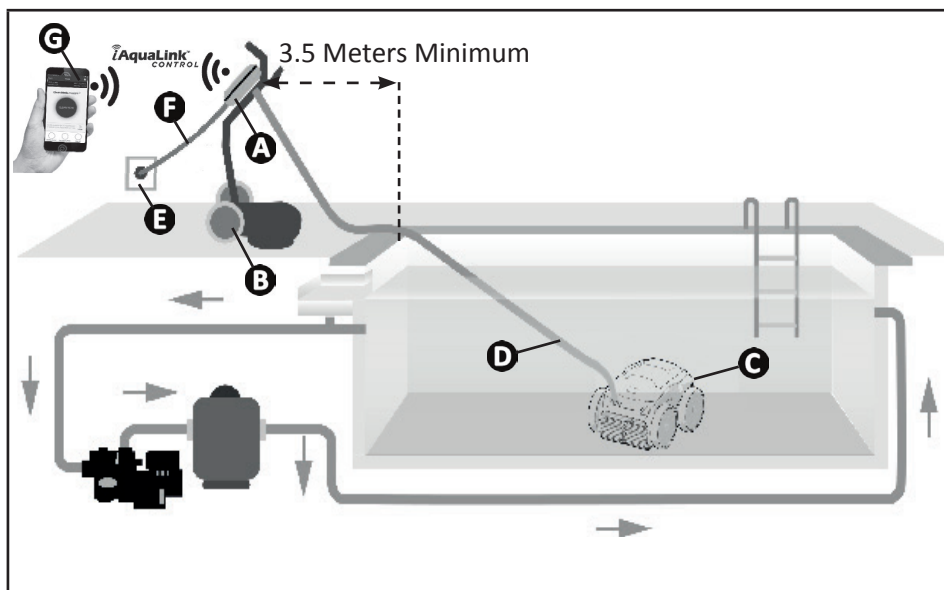

- A**: Control unit
- B**: Caddy
- C**: Cleaner
- D**: Floating cable
- E**: Plug
- F**: Mains cable
- G**: "iAquaLink™" Wi-Fi remote control

EN

2.2 | Assembling the caddy



• Tool-less assembly

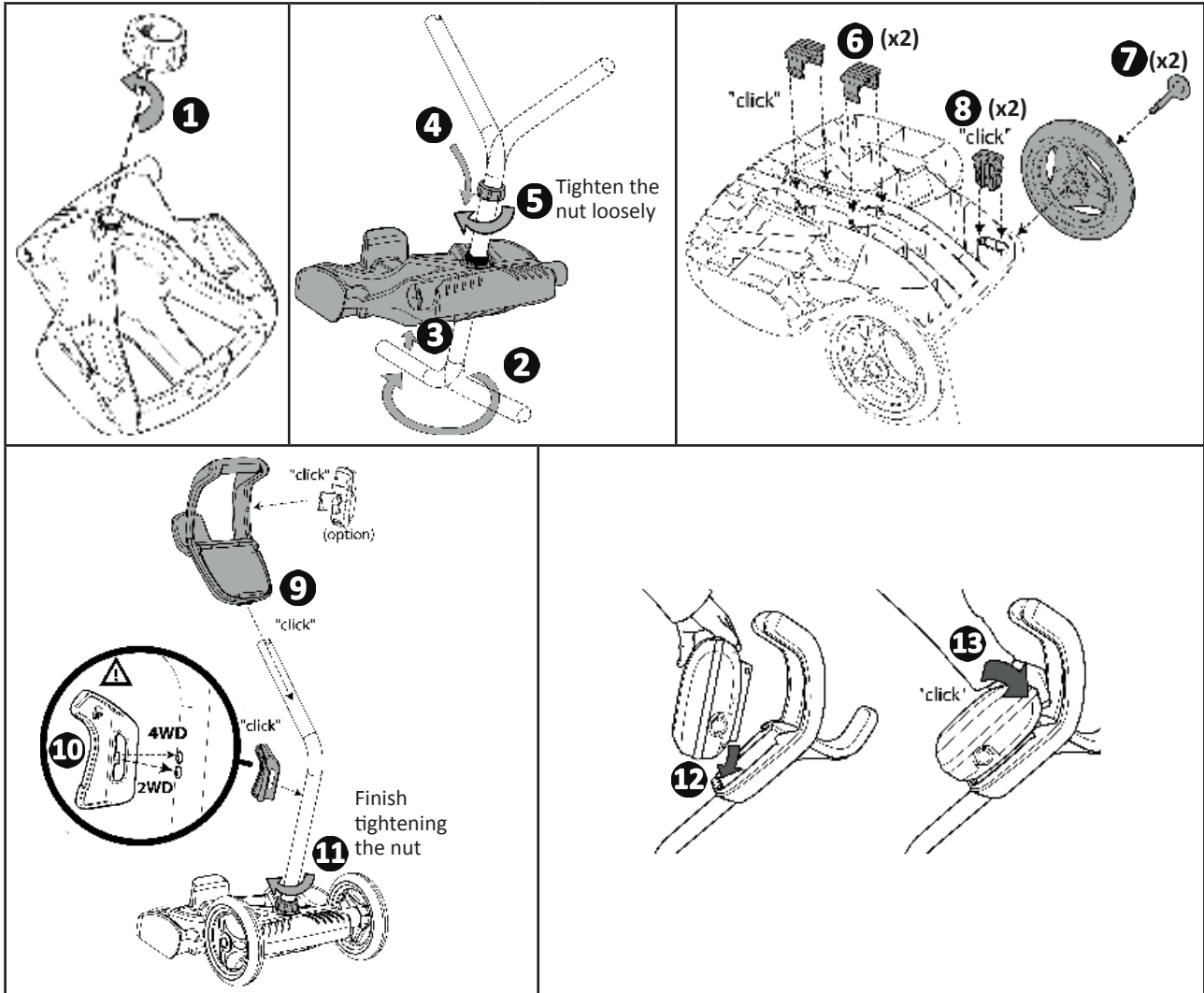



3 General use

3.1 | Operating principle

The cleaner is independent of the filtration system and can therefore operate autonomously. It just simply needs to be connected to the mains power supply.

It finds the best route to move around and clean the areas of the pool for which it has been designed (depending on the model: bottom, walls, water line). Debris is collected and held in the cleaner's filter.

The cleaner may be operated using one of the following methods:

- The control box, included with the robotic cleaner system,
- A smartphone or tablet which is compatible with the iAquaLink™ application (see "4 Control using the iAquaLink™ app").

3.2 | Pool preparation



- This product is intended to be used in pools which are permanently installed. Do not use it in pools which may be dismantled. A permanent pool one which is built into the ground or on the ground and cannot be easily dismantled and stored.

- The device must operate in pool water of the following quality:

Water temperature	Between 15°C and 35°C
pH	Between 6.8 and 7.6
Chlorine	< 3 mg per L

- When the pool is dirty, especially when commissioning, remove the larger debris using a net in order to optimise the device's performance.
- Remove any thermometers, toys and other objects that might damage the device.

3.3 | Immersing the cleaner in the pool water

- Roll out the full length of the cable alongside the pool to prevent it from becoming entangled during immersion (see image 1).
- Position yourself halfway along the length of the pool before immersing the cleaner (see image 2). This will optimise the cleaner's movements and reduce tangling in the cable.
- Lower the cleaner vertically into the water (see image 3).
- Move it slightly in all directions so that any air trapped in it can escape (see image 4).
- It is essential that the device sinks on its own and settles on the pool bottom. When it is immersed, the cleaner draws the length of cable it needs into the pool (see image 5).

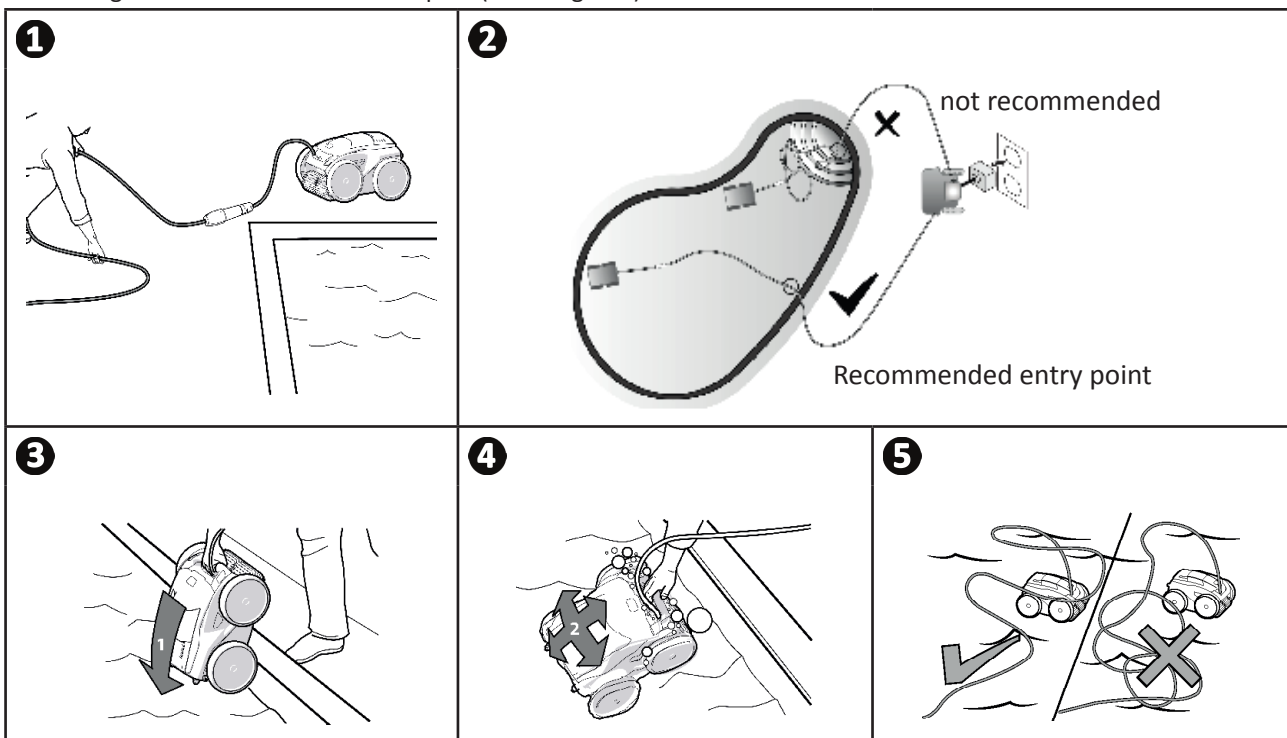

➤ 3.4 I Electrical supply connections

To prevent risk of electrocution, fire, or serious injury, be sure to adhere to the following:



- The use of an electrical extension cord is prohibited when connecting the control unit.
- Make sure that the socket is easily accessible at all times and is protected from rain or splashes.
- The control box is splash-proof but must not be immersed in water or any liquid. It must not be installed in a floodable area; keep it at least 3.5 metres away from the edge of the pool and avoid exposing it to direct sunlight.
- Position the control unit close to the socket.

- Unscrew the protective cap (see image ①).
- Connect the floating cable to the control unit and lock it into place by turning it clockwise (risk of damage to the floating cable) (see image ②, ③).
- Make sure that the connector is fully pushed in so that no water can get in (see image ④).
- Connect the mains cable (see image ⑤). The control unit should only be connected to a power outlet protected by a 30mA maximum, Residual Current Device (RCD) (if in doubt contact a qualified technician).

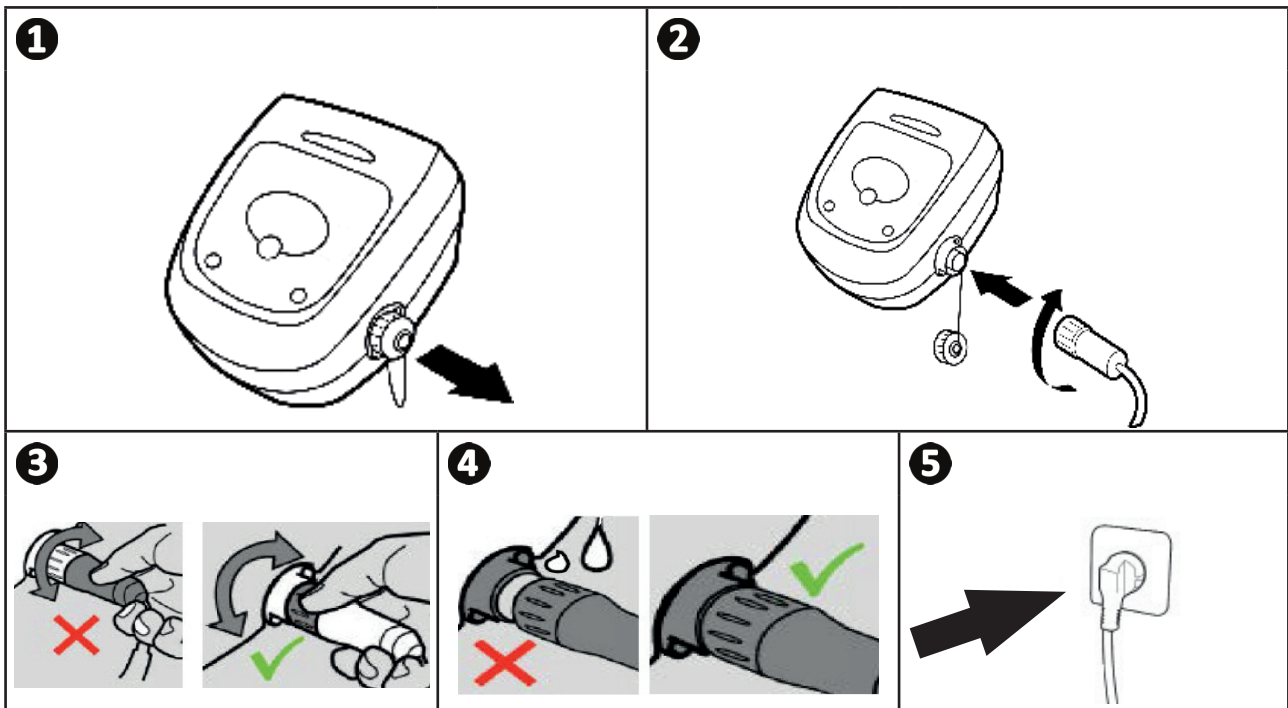

3.5 I Starting and stopping a cleaning cycle

To prevent risk of injury or property damage, be sure to adhere to the following:









- Bathing is prohibited while the device is in the pool.
- Do not use the device during a shock chlorination. Wait until the chlorine level has reached the recommended value before immersing the cleaner.
- Do not leave the device unattended for an extended period.
- Do not use the device if the rolling cover is closed.

- When there is power to the control unit, the following symbols light up to indicate:
 - The action in progress
 - The cleaning selected
 - Maintenance required
- The control unit switches to standby after 5 minutes, the screen and LED switches off. Simply press a button to come out of standby. Standby mode does not stop the device operating if it is in a cleaning cycle.

EN

3.5.1 Choice of cleaning mode

- By default, **Smart mode** is the pre-set cleaning mode (cleaning the floor, walls and waterline over an optimised period of time depending on the pool's dimensions).
- During the first cycle launched in Smart mode, the cleaner explores the pool while cleaning for a cycle lasting 2 hours and 30 minutes. During this first cycle, the control box displays "AUTO / 2h30" (depending on the model). At the end of this cycle, the optimum cleaning time is calculated.
- This optimum cleaning time is then saved and becomes the default cleaning time for future cycles launched in Smart mode. The control box then displays the optimum time calculated.
- To reset Smart mode, press and hold the button  for 5 seconds. Launch a new cycle in Smart mode so that the cleaner recalculates the optimum cleaning time.
- The cleaning cycle can be modified before the device starts or while it is operating. The new mode will be started immediately and the remaining time from the previous cycle will be canceled.
- Press  :
 - **Quick Mode (Quick cleaning bottom only):** 
 - **Smart Mode (Optimised cleaning of the bottom, sides and water line):** 
 - **Ultra mode (Intensive cleaning the bottom, sides and water line):**  (in accordance to the model)
 - **Water line mode only:**  (in accordance to the model)
- Press  to start the cleaning cycle.





Tip: to improve cleaning performance

At the start of the bathing season, run a few cleaning cycles in bottom only mode (after removing any large debris with a net).

Regular use of the cleaner (not more than 3 times a week) will keep your pool permanently clean and the filter less clogged.

3.5.2 Adjusting the cleaning time (depending on model)

- You may reduce or increase the time for the cleaning cycle selected or in progress:
 -  : Reduce by 15 minutes.
 -  : Increase by 15 minutes.

3.5.3 Ending the cleaning cycle

To prevent damaging the equipment:



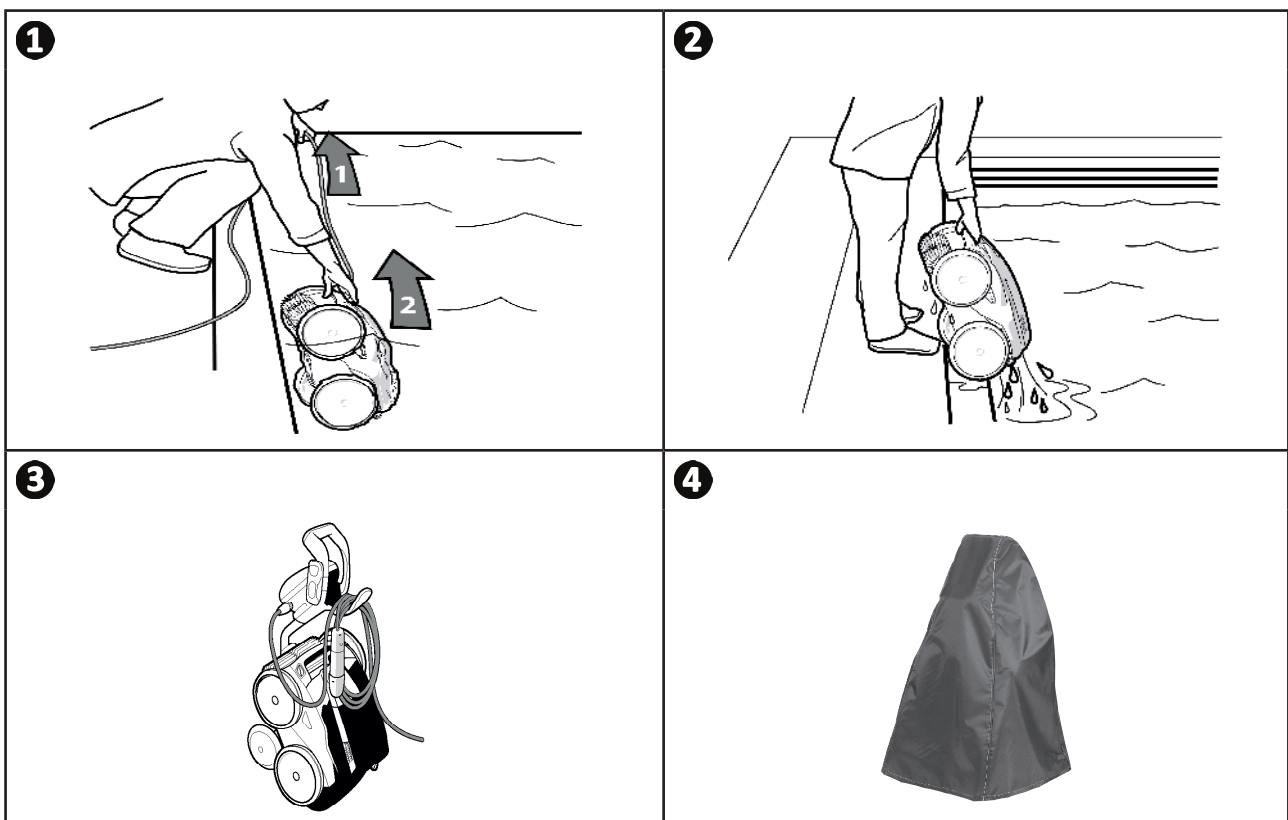

- Do not pull on the cable to remove the appliance from the pool. Use the handle.
- Do not leave the appliance to dry out in sunlight after use.
- Store all the elements away from sunlight, humidity and bad weather.
- Screw the protective cap back on if you unplug the control box power cord.

- Switch off the device by pressing .
- When the cleaner is within arm's reach, pick it up by the handle (see image **1**) and lift it gently out of the pool so that the water it contains drains into the pool (see image **2**).
- Place the cleaner vertically in the location provided on the caddy for it to dry out quickly (see image **3**).
- Then store it with the control unit away from sunlight and anywhere it might be splashed with water. A protective cover is available as an option (see image **4**).



3.5.4 "Out of water" mode

This function enables the cleaner to be returned to an exact point at the edge of the pool. As it is lifted from the water, the cleaner sprays a jet of water behind it to make it lighter.

- Direct the cleaner towards the required pool wall, then make it climb to the water line: keep pressure on  to tilt it . The cleaner moves towards the wall when you release the button.



Tip: avoid the floating cable becoming too entangled

The cleaner's behaviour is strongly affected by the cable becoming tangled. A cable which is correctly untangled will ensure better coverage of the pool.

- Untangle the cable and lay it out in the sun so that it returns to its original shape.
- Then roll it up carefully and place it on the caddy handle.



4 Control using the iAquaLink™ app

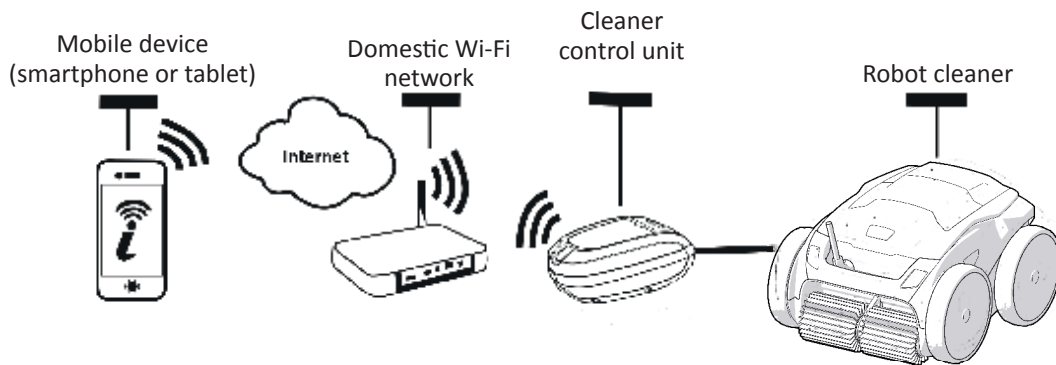

EN

The iAquaLink™ app is available for iOS and Android systems. With the iAquaLink™ app you can control the cleaner from any location at any time and have the benefit of advanced functions such as additional programming and troubleshooting assistance.







Before you install the app, you must:

- Connect the control unit to the power,
- Immerse the cleaner in the pool,
- Use a smartphone or tablet connected to Wi-Fi,
- Use a smartphone or tablet able to run iOS 11.0 and above and Android 5.0 and above.
- Use a Wi-Fi network with a reasonably powerful signal when connecting to the cleaner's control unit.
- Have your home Wi-Fi network password at the ready.

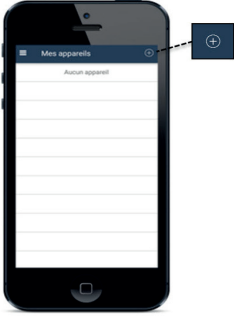
4.1 Connecting to the iAquaLink™ app

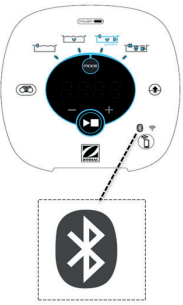
- Download the iAquaLink™ app from the App Store or Google Play Store.

<p>1</p>  <p>Log in or register.</p>	<p>2</p>  <p>Add a system, select the model type and sign-in.</p>	<p>3</p>  <p>Press the button.</p>
<p>4</p>  <p>The Bluetooth LED flashes (for up to 3 minutes).</p>	<p>5</p>  <p>The Bluetooth LED stops flashing when paired to phone.</p>	<p>6</p>  <p>Choose the home Wi-Fi network and enter the Wi-Fi password.</p>

7



The Wi-Fi LED flashes when connected to the home router and the Bluetooth LED turns off.

8

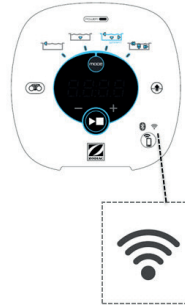

The connection to the internet is established when the Wi-Fi LED is solid.



- It can take several minutes to connect.
- If an error message appears or the connection still isn't made, refer to table "6.3 I Troubleshooting the connection to the iAquaLink™ application".
- Once configured, the cleaner is displayed in "**My Systems**" when next connecting to the iAquaLink™ application.

4.1.1 Initial settings

- **Customise the cleaner's name** so that it can be found easily in the "**My Devices**" page if there are several devices connected to the iAquaLink™ application;

➤ 4.2 I iAquaLink™ control



Before controlling the cleaner with the application, take care to:

- Connect the control box to a power outlet,
- Immerse the cleaner in the pool.

EN

4.2.1 Programming and controlling cleaning cycles

From the application:

- **Start, stop cleaning;**
- **View the current cycle's remaining cleaning time** (displayed in hours and minutes);



- The remaining time is not displayed during the first Smart mode cycle. The first Smart cycle is used to "inspect" the pool to determine optimal cleaning time. This optimized cleaning time is displayed from the 2nd cycle, and shows how much cleaning time remains.

- **Increase, reduce the cleaning time** by sequences of 15 minutes (depending on model);
- **Choice of pre-set cleaning modes:** Quick cleaning, Smart cleaning, Ultra cleaning, Water line only cleaning (depending on model);



- The new cleaning mode will take effect for the cleaning cycle in progress and all future cycles.
- The cleaning cycle time may vary depending on the selected settings.

- **Schedule cleaning cycles (days and hours) (depending on model);** Cleaning cycles may be programmed to repeat, only one program can be set per day;
- **Check the pool's temperature during the cleaning cycle (depending on model);**

The cleaner measures the water temperature while operating.



- When the cleaner is at the bottom of the pool, it is normal to see a difference between the temperature measured by the cleaner and the temperature measured by a thermometer placed on the pool's surface, or which is measured by another device.

4.2.2 "Lift System" function for helping to remove the cleaner from the water

The "Lift System" function was designed to facilitate removing the cleaner from the water. It may be activated at any time, during or at the end of a cleaning cycle.



- **Only activate the Lift System function if the cleaner is in view.**

- To guide the cleaner to the required wall, use the right or left arrow;
- When the cleaner is opposite the wall, press the "Lift System" button . The cleaner will start to move to the pool wall and climb to the waterline;
- Using the handle, lift the cleaner from the water. At this point, the cleaner will expel a powerful jet of water. It will then be lighter to lift from the pool.
- Fully remove the cleaner from the water.



- **Do not pull on the floating cable to lift the cleaner out of the water; use the cleaner's handle.**
- **You are strongly encouraged to remove and clean the filter after each cleaning cycle.**

4.2.3 Remote control (according to model)

The cleaner can be controlled using your smartphone or tablet as a remote control.



- Use the remote control mode only if you have the cleaner within view.

- **2 modes are available** for piloting the cleaner:

"**Joystick mode**": Press the icons to move the cleaner **forwards and backwards** and to turn **left or right**.

"**Kinetic mode**": Control the cleaner by tilting the mobile device **upwards** (backwards movement), **downwards** (forward movement), **to the left** (turn left), **to the right** (turn right).

- The "**Spot Cleaning**" function can be used **for specific areas** (depending on the model): when this function is activated, the cleaner cleans a 1m² area in front of it.



- If the cleaner is relatively slow to respond to an action requested in the app, check the Wi-Fi network signal, see "**4.1 | Initial cleaner set-up**"

4.2.4 Error messages

- If an error is detected, a warning symbol will be displayed

Press the warning symbol to display the troubleshooting solutions, see "**6.2 | User alerts**".

Select **Clear Error** if you think you have solved the problem, or select **OK** if you want to leave the cleaner in error mode and troubleshoot the problem later.

4.2.5 Settings

At any moment, **some settings can be modified** by pressing the **Settings** icon.



5 Maintenance



To avoid serious injury:

- Disconnect the cleaner from the power.

5.1 | Cleaning the cleaner

- The device must be cleaned regularly using clean or slightly soapy water. Do not use solvents.
- Rinse the device generously using clean water.
- Do not let your device dry in the sun by the pool.



Tip: replace the filter and the brushes every two years

It is recommended that you change the filter and the brushes every 2 years to preserve the integrity of the device and guarantee optimum performance.

5.2 | Cleaning the filter



- The cleaner's performance may be reduced if the filter is full or dirty.
- Clean the filter with clean water after each cleaning cycle.

- If the filter is blocked, clean it with an acid solution (white vinegar, for example). It is recommended that you do this at least once a year, since the filter will clog if not used for several months (winter period).

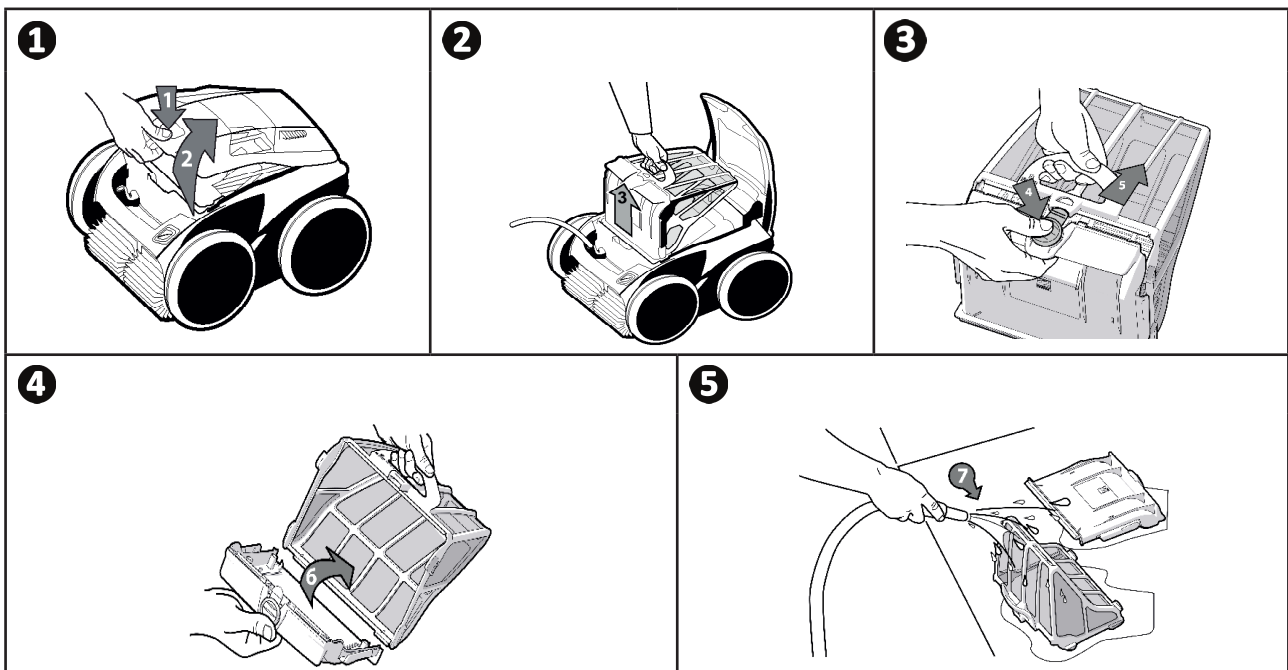

Tip: Check the status of the "full filter" indicator

When the LED illuminates, it is strongly recommended that you clean the filter.

5.3 I Cleaning the propeller

To avoid serious injury:



- Disconnect the cleaner from the power.
- You must wear gloves when doing maintenance on the propeller



- Loosen the screw on the grille (see image 1).
- Remove the grille (see image 2).
- Remove the flow guide carefully (see image 3).
- To remove the propeller, wear gloves and hold the end of the propeller carefully when pushing it (see image 4).
- Remove all debris (hair, leaves, stones, etc.) which may be blocking the propeller.

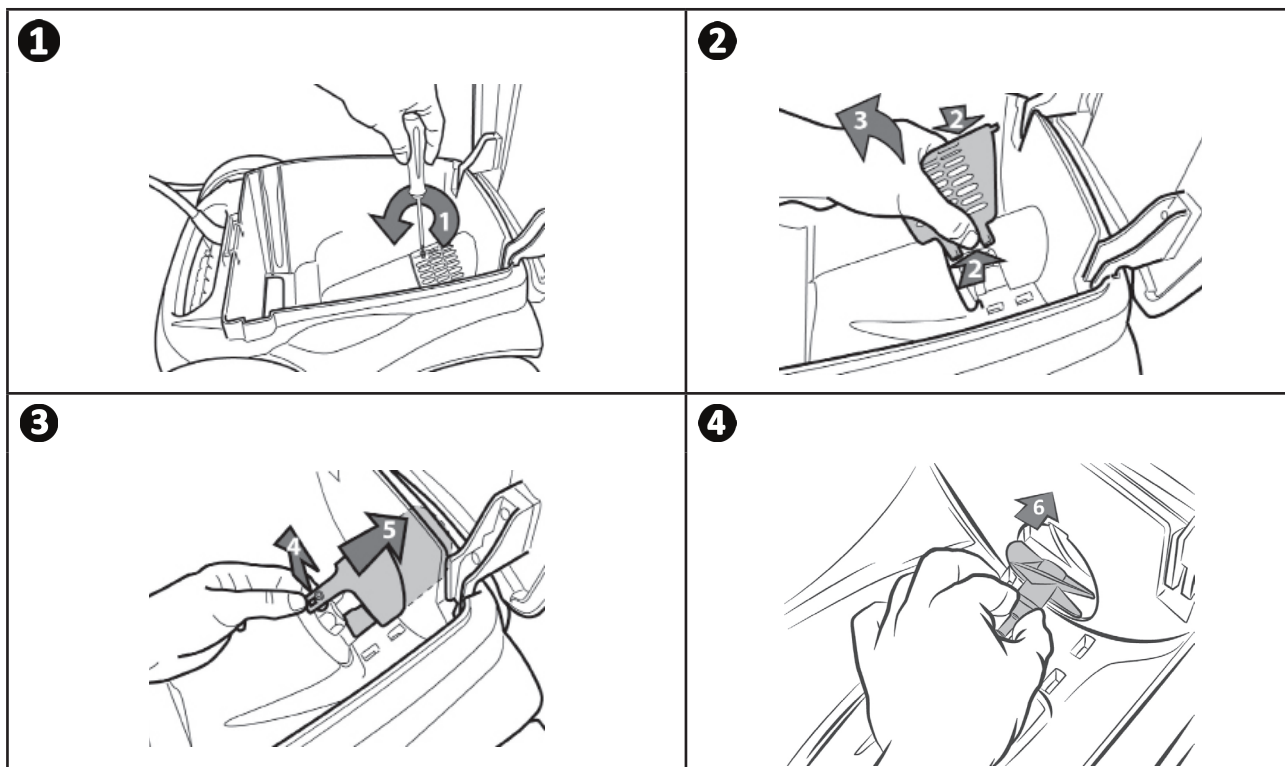

➤ 5.4 I Replacing the brushes

Are the brushes worn?

- Replace the brushes if the wear indicators are similar to example : **B** :

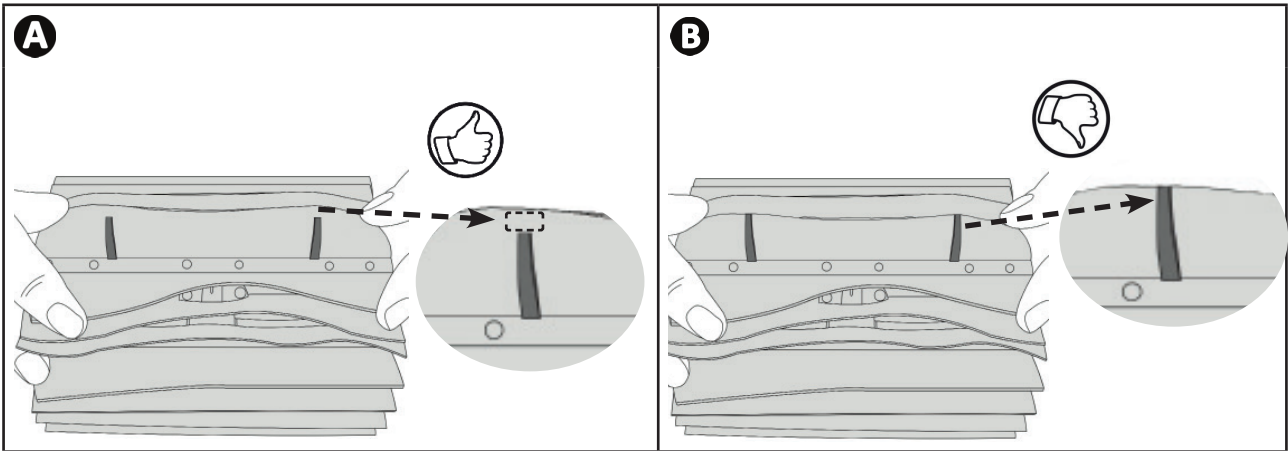

EN

Remove the worn brushes

- Remove the tabs from the holes in which they are fixed.

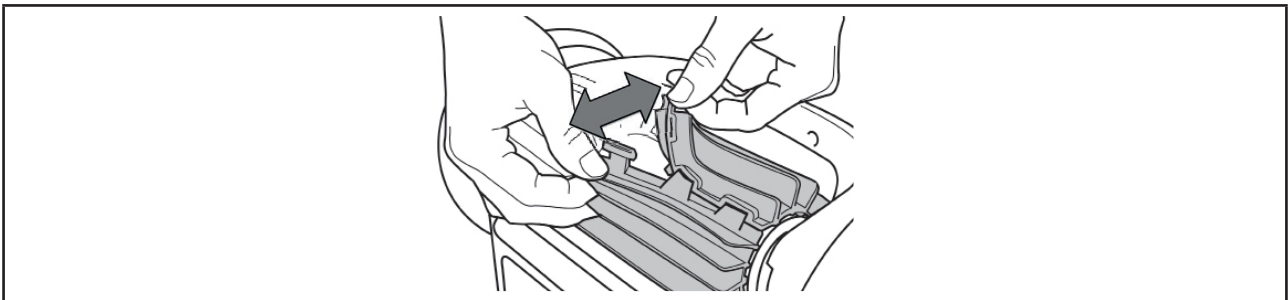

Position the new brushes.

- Start by fitting the side without tabs under the brush holder (see image **1**).
- Roll the brush around its support, slide the tabs into the attachment holes and pull on the end of each tab until its edge passes through the slit (see image **2**).
- Cut the tabs using a pair of scissors for them to be level with the other blades (see image **3**).

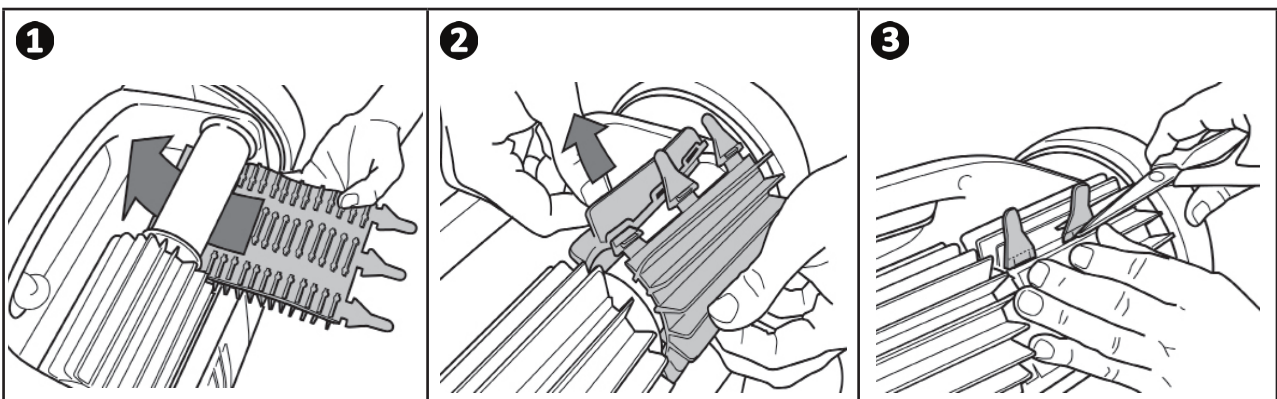

➤ 5.5 I Changing the tyres

Remove the worn tyres

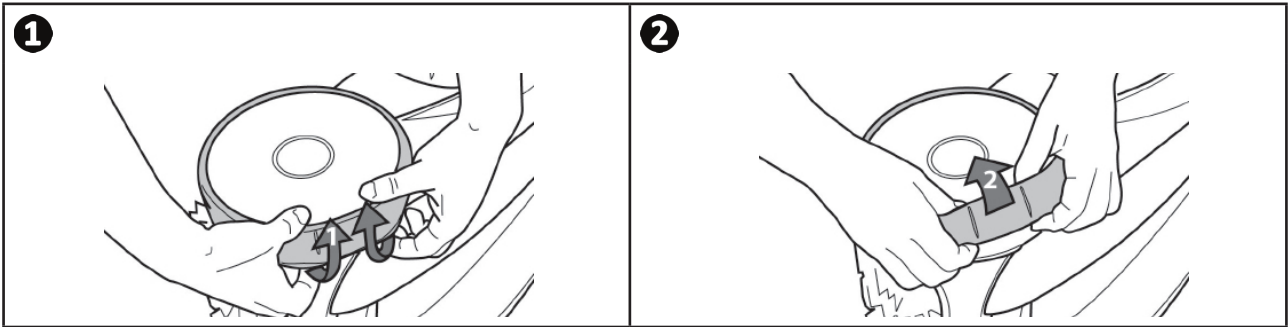

Position the new tyres

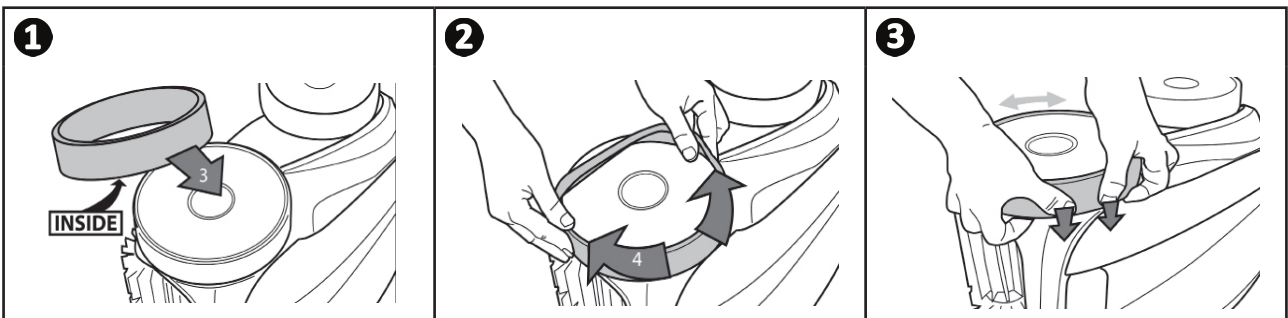





6 Troubleshooting



- Before you contact your retailer, we invite you to carry out some simple checks for yourself in the event of a malfunction, using the following tables.
- If the problem continues contact your retailer.
-  : Actions reserved for a qualified technician.











EN

6.1 I Appliance behaviour

Part of the pool is not correctly cleaned.	<ul style="list-style-type: none"> • Repeat the immersion steps (see "3.3 I Immersing the cleaner in the pool water") varying the immersion location until you find the right place in the pool.
The appliance does not stay firmly on the pool bottom	<ul style="list-style-type: none"> • There is still air in the appliance's casing. Repeat the immersion steps (see "3.3 I Immersing the cleaner in the pool water"). • The filter is full or clogged: clean it with fresh water. If the filter is blocked, clean it with an acid solution (spirit vinegar, for example). Replace the filter if necessary. • The propeller is damaged: 
The appliance does not or no longer climbs the pool sides as it originally did.	<ul style="list-style-type: none"> • The filter is full or clogged: clean it with fresh water. If the filter is blocked, clean it with an acid solution (spirit vinegar, for example). Replace the filter if necessary. • The tyres are worn: replace them. • Even though the water seems clear, microscopic algae are present in your pool; they are not visible to the naked eye but they make the sides slippery and prevent the device from climbing. Carry out shock chlorination and reduce the pH slightly. Do not leave the appliance in the water during shock treatment.
The appliance does not perform any movements on start-up.	<ul style="list-style-type: none"> • Check that the control unit's power socket is receiving a power supply. • Check that a cleaning cycle has been launched and that the lights are on.
The cable is tangled.	<ul style="list-style-type: none"> • Do not unroll the entire length of cable in the pool. • Place the required length of cable in the pool and spread the rest along the side of the pool.
The control unit does not respond to any button presses.	<ul style="list-style-type: none"> • Unplug the cable from the mains socket, wait 10 seconds and plug it back in again.
The sensor LED is off even though the cleaner is operating.	<ul style="list-style-type: none"> • Contact the dealer  to check the condition of the sensor unit.

If the problem persists, contact your retailer: 

6.2 | User alerts

Control Unit Display		In-App Display	Suggested Solution
Error code (in accordance to the model)	Blinking LED (in accordance to the model)		
Er : 01	 x 3	Pump Motor	<ul style="list-style-type: none"> Check for any small debris or cable impeding the brushes from turning freely. Check for corrosion or bent pins in the power cable connection area. Turn each wheel one quarter turn in one direction repeatedly until rotation is smooth.
Er : 02 Er : 03	 x 2	Traction Motor Right Traction Motor Left	<ul style="list-style-type: none"> Repeat, turning wheels in the opposite direction until rotation is smooth. If this does not solve your problem, please contact your local retailer for a diagnostic review or call customer service.
Er : 04	 x 3	Pump Motor Consumption	<ul style="list-style-type: none"> Check for small debris or hair in fan impeller. Thoroughly clean filter canister. If this does not solve your problem, please contact your local retailer for a diagnostic review or call customer service.
Er : 05 Er : 06	 x 2	Drive Motor Consumption Right Drive Motor Consumption Left	<ul style="list-style-type: none"> Check for any small debris or cable impeding the brushes from turning freely. Check for corrosion or bent pins in the power cable connection area. Turn each wheel one quarter turn in one direction repeatedly until rotation is smooth. Repeat, turning wheels in the opposite direction until rotation is smooth. If this does not solve your problem, please contact your local retailer for a diagnostic review or call customer service.
Er : 07 Er : 08	 x 3	Cleaner Out of the Water	<ul style="list-style-type: none"> Turn off the cleaner and submerge. Thoroughly clean the filter canister. Shake to release air bubbles. Restart cycle. If this does not solve your problem, please contact your local retailer for a diagnostic review or call customer service.
Er : 10	 x 1	Communication	<ul style="list-style-type: none"> Turn cleaner power off and on again to reset. Check floating cable connection to control box. Check for corrosion or bent pins at connection point. If this does not solve your problem, please contact your local retailer for a diagnostic review or call customer service.
Er : 11	 x 4	Sensor unit	<ul style="list-style-type: none"> Contact the dealer  to check the condition of the sensor unit.
Er : 12	 x 5	Prog Failed or incompleted	<ul style="list-style-type: none"> Unplug the control box and plug it back in to restart the update process. If the error reappears, contact a retailer.
PROG	 continuously	A software update is in progress.	<ul style="list-style-type: none"> Wait the end of the software update. Do not unplug from power during an update.
N/A	N/A	Connection Error	<ul style="list-style-type: none"> Check the status of the Bluetooth/ WiFi LED on the control box and follow the steps described in the table "6.3 Troubleshooting the connection to the iAquaLink™ app".
N/A	N/A	A red dot appears in the "My appliances" list	<ul style="list-style-type: none"> "Appliance not plugged in or not connected to the home Wi-Fi network. If the dot is red when the control box is plugged in and if the Bluetooth/ WiFi icons are lit up, refresh the screen (by swiping downwards). If the dot turns green: the appliance is ready for use."

Dismissing an Error Code

From the Control Unit:

- After you have completed the troubleshooting solution steps, press any key to clear the error code (except the  button).







From the iAquaLink™ App:



- After you have completed the troubleshooting solution steps, press **Clear Error** to return to normal operation. Or, press **OK** if you need to complete the solution steps at a later time.

EN

6.3 I Troubleshooting the connection to the iAquaLink™ app

- Before you connect to a new Wi-Fi network, re-initialise the parameters of your current Wi-Fi network or simply change the Wi-Fi password. You will have to re-make the connection between the control unit and the new Wi-Fi network, see "4.1 I First-time cleaner configuration".

Control unit status	Possible causes	Solutions
<ul style="list-style-type: none"> • The LED  flashes. 	<ul style="list-style-type: none"> • The control box is connected on router but not on cloud server (LAN connected, WEB not connected). • The 5Ghz router is non compatible. 	<ul style="list-style-type: none"> Contact your Internet service provider. • Disconnect the home Wi-Fi network for 10 seconds. Re-connect it and see whether the LED come back on. • Check the internet connection - Network may be down. • Replace the router.
<ul style="list-style-type: none"> • All LED are off. 	<ul style="list-style-type: none"> • Bright sunlight. 	<ul style="list-style-type: none"> • Shield the lights to block sunlight and check again whether the lights are lit.
	<ul style="list-style-type: none"> • Control unit disconnected. 	<ul style="list-style-type: none"> • Connect the control unit (see "3.4 I Electrical supply connections").
	<ul style="list-style-type: none"> • Power cut. 	<ul style="list-style-type: none"> • Check that there is power to the circuit breaker. • Check that there is power to the socket by connecting another device to it.
	<ul style="list-style-type: none"> • Internet connection lost. 	<ul style="list-style-type: none"> • Check the internet connection - Network may be down.
<ul style="list-style-type: none"> •  LED is off. 	<ul style="list-style-type: none"> • Internet connection lost. 	<ul style="list-style-type: none"> • Check the internet connection - Network may be low. • Ensure that you have a sufficiently strong Wi-Fi signal. There are several ways to check the strength of the Wi-Fi signal: <ul style="list-style-type: none"> - Unplug the home Wi-Fi router, then plug it back in. - Using a portable computer, go into Configuration Panel to see the state of your network connections. Check the strength of the wireless network Wi-Fi signal on the portable computer while looking at the control unit. - Install the iAquaLink™ app, using a smartphone or tablet. Check the strength of the wireless network Wi-Fi signal on the mobile device while looking at the control unit. If the Wi-Fi network is weak, install a Wi-Fi extender. Utiliser une application dédiée à l'analyse Wi-Fi : il en existe plusieurs dans iOS ou Android. • On first set-up, Move the control unit closer to the home Wi-Fi router. Do not use an extension lead (see "3.4 I Electrical supply connections"), then repeat the configuration steps (see "4.1 I First-time cleaner configuration") : <ul style="list-style-type: none"> - Once the  LED light up, plug in the control box near the pool. - If the  LED do not light up, plug in the control box again as close to the house as possible. - If the  LED still do not light up, install a Wi-Fi extender.
<ul style="list-style-type: none"> •  LED is on but the Wi-Fi network is non-existent (or spotty). The "Connection Error" message is displayed on the screen in the iAquaLink™ app. 	<ul style="list-style-type: none"> • Weak Wi-Fi signal*. 	
<ul style="list-style-type: none"> • The control unit is too far from the home Wi-Fi network. 		

Control unit status	Possible causes	Solutions
<ul style="list-style-type: none"> The  LED is ON and it's displaying "PROG" on the control box (in accordance to the model) and information is displayed in the app. The buttons can't be activated. The LED  is not lit during this operation. 	<ul style="list-style-type: none"> A software update is in progress. 	<ul style="list-style-type: none"> Wait the end of the software update. Do not unplug from power during an update.

***A weak Wi-Fi signal can occur for several reasons:**

- The distance between the router and the control box of the cleaner,
- The type of router,
- The number of walls separating the router and the control box of the cleaner,
- The internet access provider,
- etc.

Votre revendeur
Your retailer

Modèle appareil
Appliance model

Numéro de série
Serial number

Pour plus d'informations, enregistrement produit et support client :
For more information, product registration and customer support:

www.zodiac.com

